

VERZUS 710RS/RSB

Rockwell / Brinell hardness tester



VERZUS 710RS/RSB Rockwell/Brinell hardness tester



VERZUS 710RS/RSB Rockwell/Brinell hardness tester

The VERZUS 700 series are a new generation of hardness testing instruments. Constructed around a rock solid C-frame with unparalleled rigidity. The closed loop system based on a load cell and precision force actuator guarantees the best GR & R results ever seen on Rockwell hardness testers.

The tester meets or exceeds the ISO, ASTM and JIS standards and easily passes Nadcap auditing.

Test forces range from 1kgf/9.8N to 250kgf/2.45kN, state of art electronics, superior digital filter technology, advanced algorithms provide unmatched force control and excellent repeatability.

A full test cycle can be as little as 13 seconds (at a dwell time of 10 seconds).

Depth measurement via an optical system with a direct depth reading of 0.1 micron.

VERZUS stands for versatile.

Even the most basic model is equipped with Rockwell, Superficial Rockwell, HVT, HBT and Depth ball measurement.

All models include testing scales for plastic according to ISO 2039/1 and 2.

For demanding users the VERZUS can be equipped with a motorized spindle that lifts your work piece, without any effort, to the required testing position.

The model VERZUS 710RSB is supplied with a Brinell Indent Optical Scanner (BIOS) showing crisp Brinell indent images on the LCD screen. Fully automatic Brinell Indent measurement up to 250kgf testforce.

The outer skin of the tester is made of recyclable top class materials. The base is covered by a ABS shell that can withstand the harshest environments. No damage caused from falling testblocks or workpieces.

VERZUS, if being certain is your priority!

Wide force range

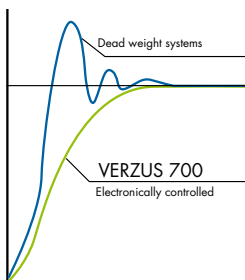

A wide force range, for Rockwell, Brinell and more.
1kgf up to 250kgf over load cell, closed loop system.

Electronically controlled loads secure a quick and precise load application as well as a quick test method change. A touch on the screen makes the correct setting.

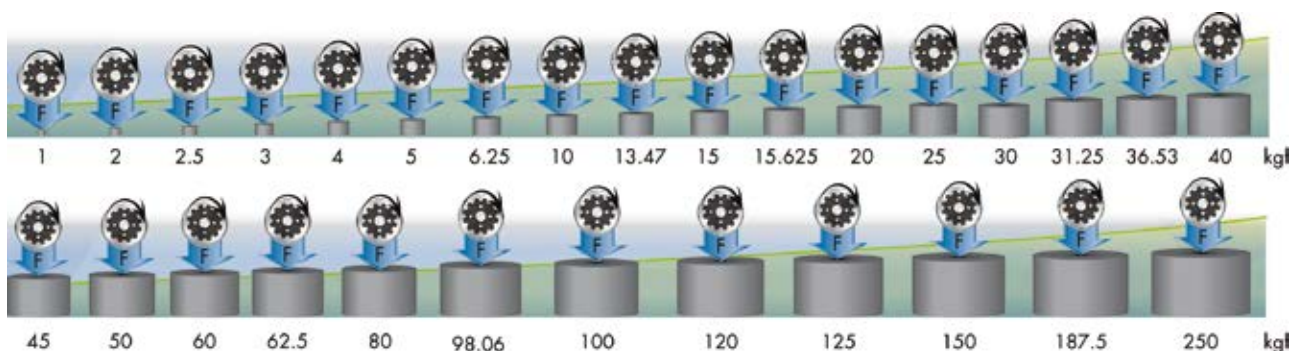

VERZUS 710RS

Rockwell/Brinell hardness tester



Overview of model configurations

710RS versus 710RSB

710RS

Rockwell
Superficial Rockwell
HVT(Vickers depth reading)
HBT (Brinell depth reading)
Plastic scales according to ISO 2039 1 & 2

710RSB

Rockwell
Superficial Rockwell
Brinell
HVT(Vickers depth reading)
HBT (Brinell depth reading)
Plastic scales according to ISO 2039 1 & 2

Scales and testing methods, depending on force configuration

Rockwell - DIN EN ISO 6508, ASTM E-18



PRE LOAD 3kgf & 10kgf
MAIN LOAD 15kgf, 30kgf, 45kgf, 60kgf, 100kgf & 150kgf

Brinell - DIN EN ISO 6506, ASTM E-10

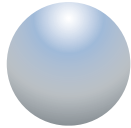

HB1/1kgf, HB1/1.25kgf, HB1/2.5kgf, HB1/5kgf, HB1/10kgf, HB1/30kgf;
HB2.5/6.25kgf, HB2.5/7.8125kgf, HB2.5/15.625kgf, HB2.5/31.25kgf, HB2.5/62.5kgf,
HB2.5/187.5kgf
HB5/25kgf, HB5/31.25kgf, HB5/62.5kgf, HB5/125kgf, HB5/250kgf
HB10/100kgf, HB10/125kgf, HB10/250kgf

HVT (Vickers depth)

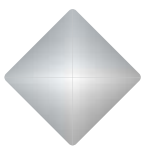

HV5 HV10 HV20 HV30 HV50 HV100 HV120

HBT (Brinell depth)

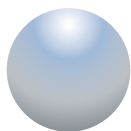

HBT1/5kgf, HBT1/10kgf, HBT1/30kgf;
HBT2.5/6.25kgf, HBT2.5/15.625kgf, HBT2.5/31.25kgf, HBT2.5/62.5kgf, HBT2.5/187.5kgf
HBT5/25kgf, HBT5/31.25kgf, HBT5/62.5kgf, HBT5/125kgf, HBT5/250kgf
HBT10/100kgf, HBT10/125kgf, HBT10/250kgf

Ball indentation - ISO-2039, ASTM D-785

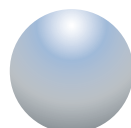

49N, 132N, 358N, 961N

IMPRESSIONS™

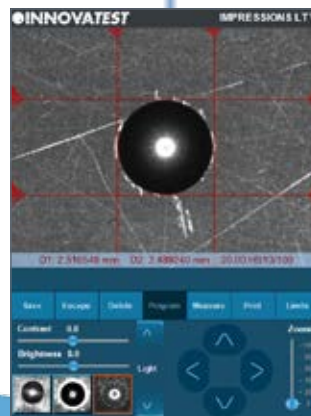
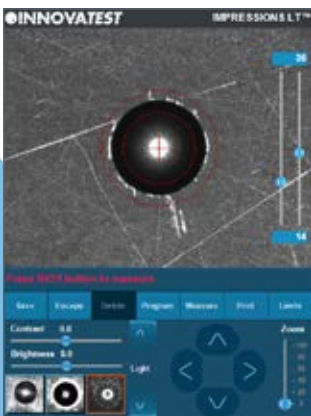

General functionality

Intuitive operator interface IMPRESSIONS™

IMPRESSIONS™ is the ultra-modern user interface of all Innovatest hardness testing machines. IMPRESSIONS™ offers unparalleled simplicity in operation but yet, includes the most advanced functions found in hardness testing. With only a minimum of operator skills required, IMPRESSIONS™ leads you through the set up process, in just seconds, not even minutes. Standard features, complex tasks and advanced work flow at your fingertips.

Typical examples are:

Scale setting, Test methods setting, Limits, Conversion to other hardness scales, Graphics, File saving, Test program saving, Zoom function, Full screen, Test pattern, CNC stage control, Focus control, Z-Axis control.

All standardized hardness testing methods have been programmed in the software and can be selected at any time.

Graphic indent process evaluation



GIPE (Graphic Indent Process Evaluation). Impressions leads the user through each second of the indentation process. Approaching the indenter, final touch, the pre-load process, the main load process and finally an overview of all parameters that have led to the actual hardness value. Visualization of the entire process creates better understanding and constant control on each phase of the testing procedure. Errors show up in clear red images of the faulty zone while a text bar gives explanation of how to correct an error.

Indent zoom magnification

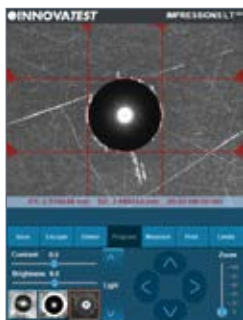

The RSB model incorporates a special designed digital USB connected microscope that transfers high resolution & crisp images to the advanced system controller and HD display. The automatic measuring software incorporated in IMPRESSIONS® work flow control reads the Brinell indent in just seconds and displays the Brinell value according to ASTM or ISO standards. A unique feature that is standard on the RSB or can be purchased later on the RS models.

Additional functionality...

Report generator (standard)



The IMPRESSIONS™ system incorporates a very advanced report generator. The report generator allows you to publish all testing results and graphics, including pictures of the Brinell indentation in an easy to edit and easy to customize file size. You can add your company details and change the reporting lay-out to your requirements.

All reports can be printed on a connected (optional) standard printer without the need of a personal computer or any interface.

Reports can be exported to excel or word or simply stored as PDF on the systems hard disks.

Easy connections



The powerful embedded micro controller running MS Windows® provides an almost unlimited connectivity to the outside world, wired, or not. Multiple USB ports, RJ45 LAN, W-LAN, BlueTooth, RS-232, HDMI & VGA are available on all models.

Motorized spindle (optional)



The Verzus 710 series also offers the option of a motorized precision spindle. The spindle moves work pieces up to 100kg to its testing position by just a push on the button. While often motorized spindles can't be controlled manually, Verzus 710 has a manual operation mode as well. This means that the tester can be operated manually over the standard installed hand wheel even if the option "motorized spindle" is installed.

Accessories...

Workpiece clamp (standard)



Anvils & test tables

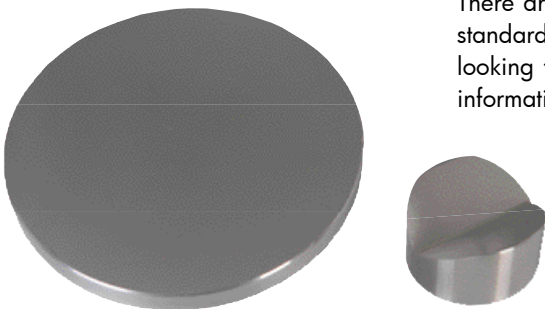

There are a large number of anvils and test tables available. Please check the standard accessories table and the optional accessories table. If the anvil you are looking for is not mentioned, please contact our sales department for updated information.

Indenters and testblocks

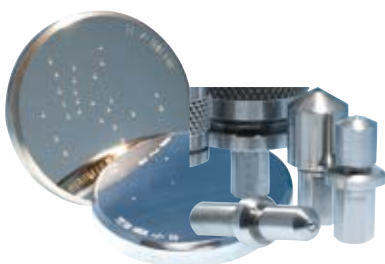

Innovatest offers MASTERBLOCK™ hardness test blocks and indenters. A wide range of ISO & ASTM traceable certified hardness comparison blocks for the periodical inspection of your hardness tester. Please contact our sales department and ask for a comprehensive catalogue or a standard set of blocks that fits the best with the machine type.

Technical specifications

Hardness scales RS	Rockwell and Superficial Rockwell all scales, HVT, HBT, Ball indentation
Hardness scales RSB	Rockwell and Superficial Rockwell and all Brinell scales (1kgf/9.8N to 250kgf/2452N)
Load application	Load cell, force feedback, closed loop system
Rockwell Pre load	3kgf and 10kgf
Rockwell main load	15kgf, 30kgf, 45kgf, 60kgf, 100kgf, 150kgf
Rockwell test scales	A, B, C, D, E, F, G, H, K, L, M, P, R, S, V
Superficial Rockwell scales	15N, 30N, 45N, 15T, 30T, 45T, 15W, 30W, 45W, 15X, 30X, 45X, 15Y, 30Y, 45Y
Brinell test load (RSB model)	1kgf/9.8N to 250kgf/2452N
Brinell test scales (RSB model)	HB1: 1kgf/9.8N, 1.25kgf/12.25N, 2.5kgf/24.5N, 5kgf/49N, 10kgf/98N, 30kgf/295N; HB 2.5: 6.25kgf/61.29N, 7.8125kgf/76.61N, 15.625kgf/153.2N, 31.25kgf/306.45N, 62.5kgf/612N, 187.5kgf/1838N; HB5: 25kgf/245.16N, 31.25kgf/306.45N, 62.5kgf/612N, 125kgf/1225N, 250kgf/2452N; HB10: 100kgf/980.7N, 125kgf/1225N, 250kgf/2452N;
HVT test scales	HV5, HV10, HV20, HV30, HV50, HV100, HV120
HBT test scales	HBT1/5kgf, HBT1/10kgf, HBT1/30kgf; HBT2.5/6.25kgf, HBT2.5/15.625kgf, HBT2.5/31.25kgf, HBT2.5/62.5kgf, HBT2.5/187.5kgf; HBT5/25kgf, HBT5/31.25kgf, HBT5/62.5kgf, HBT5/125kgf, HBT5/250kgf; HBT10/100kgf, HBT10/125kgf, HBT10/250kgf;
Ball indentation	49N, 132N, 358N, 961N
Operating system	MS Windows® Embedded , INNOVATEST IMPRESSIONS LT, 32Gb SSD harddrive for data storage
Display	6.5" full color industrial touch screen, testing results, statistics, can also be operated by mouse and keyboard
Display overview	Conversion to other hardness scales such as Brinell, Vickers, Leeb, UTM. convex, concave adjustment, machine settings, calibration
Standards	Meets or exceeds ISO, ASTM, JIS standards
Test cycles	Motorized, fully automatic, Pre load, Load, Dwell, Unload process
Indenters	Rockwell Diamond Cone: 120° Rockwell balls: 1/16", 1/8", 1/4", 1/2" Brinell Balls: 1mm, 2.5mm, 5mm, 10mm
Dwell time	Pre-load 1-99 seconds, Main load 1-99 seconds, Recovery 1-99 seconds
Connectivity	USB-2 (3x), LAN RJ45, WLAN (Optional), Wi-Fi onboard (Optional), Bluetooth (Optional)
Service connection	Software service over internet "INNOVATEST Team Viewer" pre-installed
Printer	Any MS Windows® supported printer
Optical system RSB	BIOS, Brinell Indent Optical Scanner (RSB)
Workpiece accommodation	Vertical capacity 300mm Horizontal capacity 200mm (from indenter center-line)
Operating temperature	10°C to 35°C, non-condensing
Machine dimensions	290mm x 592mm x 895mm (WxDxH)
Max. workpiece weight	100kg
Machine weight	91kg
Power supply	100V AC to 240V AC, 50Hz/60Hz, single phase

Configurations, features & accessories

Standard features

- Load cell, force feedback, closed loop system
- High performance embedded fanless micro PC
- MS Windows embedded operating system
- Excellent accuracy
- Unmatched GR & R results in its class
- Load range 1kgf/9.8N up to 250kgf/2452N
- Fully automatic operation
- Meets or exceeds ISO, ASTM and JIS standards
- Shape correction settings for curved surfaces
- Go/No Go function with visual and acoustic warning
- Large memory for measurements with statistic results
- Easy calibration function
- Testing program storage
- Testing value storage
- Standard workpiece clamping attachment
- Printer & USB (3x), RJ45-LAN, W-LAN (optional), Wi-Fi onboard (Optional), Bluetooth (Optional) output
- Wireless mouse and keyboard
- Digital USB Brinell microscope (RSB model)
- Large workpiece accommodation
- Software service over internet
"INNOVATEST Team Viewer" pre-installed

Standard configuration & accessories

- Flat anvil, hardened, $\varnothing 60\text{mm}$
- V-anvil, hardened, $\varnothing 80\text{mm}$
- Fuse 3A slow (2 pcs)
- Power cable
- BIOS, Brinell Indent Optical Scanner (RSB)
- Four adjustable feet
- INNOVATEST® certificate
- Installation and user manual

Optional features & accessories

- Certified indenters (ASTM, DIN, ISO)
- Certified reference hardness blocks (ASTM, DIN, ISO)
- Testing table, hardened, $\varnothing 180\text{mm}$
- Large testing table 350mm x 250mm with T-slot and spindle adapter
- Custom testing tables
- Goose neck indenter holder
- Precision vice for small parts, jaw width 36mm
- Precision vice for small parts, jaw width 42mm
- Precision vice for small parts, jaw width 75mm
- V-blocks and special clamps
- Manual X-Y stage 160 x 180mm, micrometer travel 25mm x 25mm
- Motorized spindle operation
- Solid tester table and storage cabinet

Order details

Standard frame size

VERZUS 710RS	1kgf - 250kgf	Rockwell, Superfical Rockwell, HVT, HBT, Ball ISO 2039 1/2	250kgf
VERZUS 710RSB	1kgf - 250kgf	Rockwell, Super Rockwell, Brinell, HVT, HBT, Ball ISO 2039 1/2	250kgf



Technical Drawing VERZUS 710/RSB

All dimensions are in mm

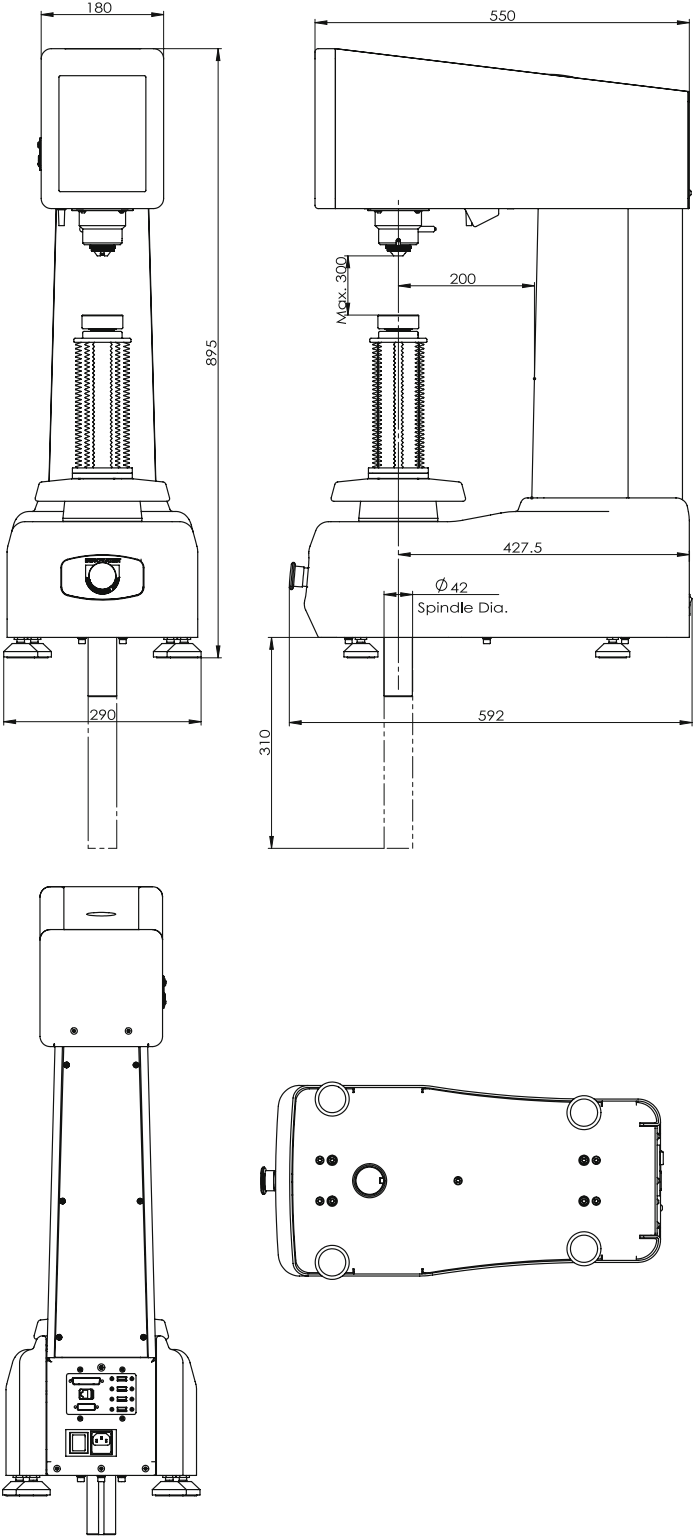



VERZUS 710RS/RSB working table

Features

- Solid stand: 710mm x 750mm x 825mm (UN-STAND/960).
- 100% retractable drawer, bearing guidance, max 100kg load. Rubber anti slip bottom
- Lockable cabinet, 360mm high
- Adjustable feet, (+/- 50mm height adjustable to reach ergonomic working position)
- Made of corrosion resistant zinc plated steel with RAL powder coating
- Carrying capacity of 400kg
- Top surface made of 50mm Plywood with 1.5mm chemical resistant plastic plating, edges made of shock resistant 3mm ABS side liner
- Industrial quality, for workshop or laboratory
- Designed for hardness testing instruments, painted in INNOVATEST® RAL colors that match with the testers.

Technical Specifications

Dimensions	710mm x 750mm x 825mm (UN-STAND/960)
Drawer	180mm
Cabinet	360mm high (lockable)

Standard Delivery

- Steel frame with table top
- 100% retractable drawer with anti-slip
- Lockable cabinet
- Adjustable feet



All dimensions are in mm

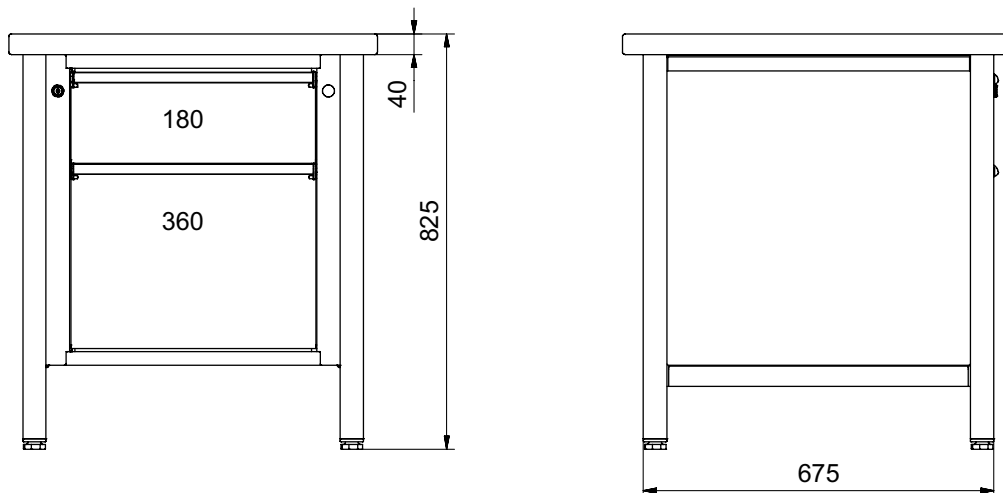

Kapcsolat, bővebb információ:



Sidex Trade Kft.

1224 Budapest, Dózsa György út 105.
TT Ipartelep (volt Mechanikai Művek)
Tel : (+36-1) 424-1705, Mobil: (+36-30) 9349-611
Fax :(+36-1) 424-1704
Web: <http://www.sidex.hu> – E-mail: info@sidex.hu

CORPORATE HEAD OFFICE

INNOVATEST Europe BV
MANUFACTURING, DISTRIBUTION & SERVICE

Borgharenweg 140
6222 AA Maastricht (The Netherlands)
Phone: +31 43 3520060
Fax: +31 43 3631168
E-mail: info@innovatest-europe.com
Website: www.innovatest-europe.com

INNOVATEST Shanghai Co., Ltd.
DISTRIBUTION, SALES & SERVICE

Building 2, No.123, 1165 Nong Jindu Road,
South Metropolis Industrial Park
Minhang District, Shanghai, P.R. China
Zip code: 201108
Phone: +86 21 60906200
Fax: +86 21 60912595
E-mail: info@innovatest-shanghai.com
Website: www.innovatest-shanghai.com

INNOVATEST SOUTH EAST ASIA
CUSTOMER SUPPORT CENTER

(c/o LMS Technologies Pte Ltd)
20 Sin Ming Lane #05-58 Midview City
Singapore 573 968
Phone: +65 6451 1123
Fax: +65 6452 1011
E-mail: info@lmstech.com.sg
Website: www.lmsscific.com